



TB6210187
with cover open



TB6210187
1 circuit



TB6220187
2 circuits

Features

- Standard housing 35 x 90 x 61 mm in line with DIN 43880 - 2 TE
- Two models: 1-circuit and 2-circuit types
- Weekly programming
- Switching function: ON - AUTO - OFF
- Automatic changeover standard time/daylight saving time for Europe, UK and the USA
- Vacation mode
- Running reserve for 6 years (in case of power failure)
- 50 programs
- Minimum switching interval: 1 minute
- Manual override key ON/OFF on the front
- Manual operation can be locked out
- Reset key
- LED operation display
- Cover can be swung open
- Cover can be secured
- Output: Relay 1c, 250V AC, 16A
- Rated operating voltage: 230V AC, 50/60Hz
- Mounting method: Wall mounting, DIN rail

Product types

Model numbers	Description	Operating voltage	Running reserve
TB6210187	Digital time switch, weekly programming, 1 circuit	220-240VAC	6 years
TB6220187	Digital time switch, weekly programming, 2 circuits	220-240VAC	6 years
TB62203777	Terminal cover and mounting plate for wall mounting		

Technical Data

Model number	TB6210187	TB6220187
Type	1 BRTU according to EN60730-2-7	
Program cycle	Weekly	
Operating voltage	220-240VAC (-15% to +10% of the operating voltage)	
Frequency	50-60Hz	
Power consumption	2W	
Switching capacity		
Resistive load (cosΦ=1)	16A / 250VAC	
Inductive load (cosΦ=0,7)	8A / 250VAC	
Number of circuits	1	2
Number of circuits	1 relay contact output	2 relay contact outputs
Contact type	1 changeover contact	2 changeover contacts
Driving method	Quartz oscillation	
Memory capacity	50 programs	50 programs/circuit
Minimum switching interval	1 minute	
Manual switching	Override function	
Changeover, standard time/daylight saving time	Yes	
Time accuracy	±15 seconds/month (at 25°C)	
Running reserve	6 years for clock memory and program (lithium battery)	
Ambient temperature	-20°C to +55°C	
Humidity	Max. 85%	
Applicable wire	Max. 2.5mm ²	
Weight	100g	120g
Protection degree	Protection degree II when mounted properly	
	IP20 according to EN60529	
Pollution degree	3	
Overvoltage category	III	

Dimensions, Part names

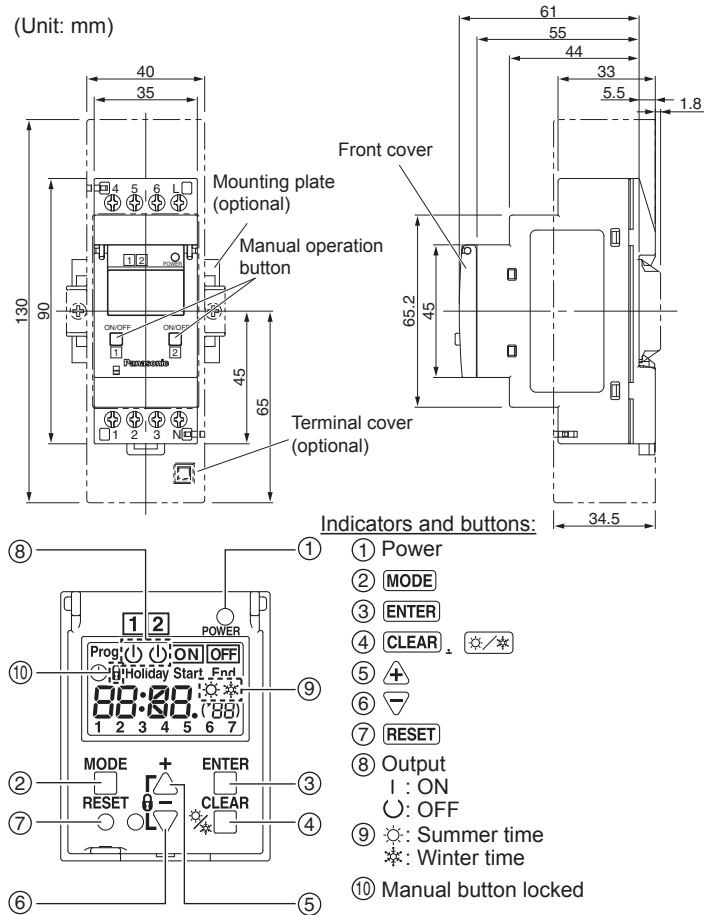

Mounting

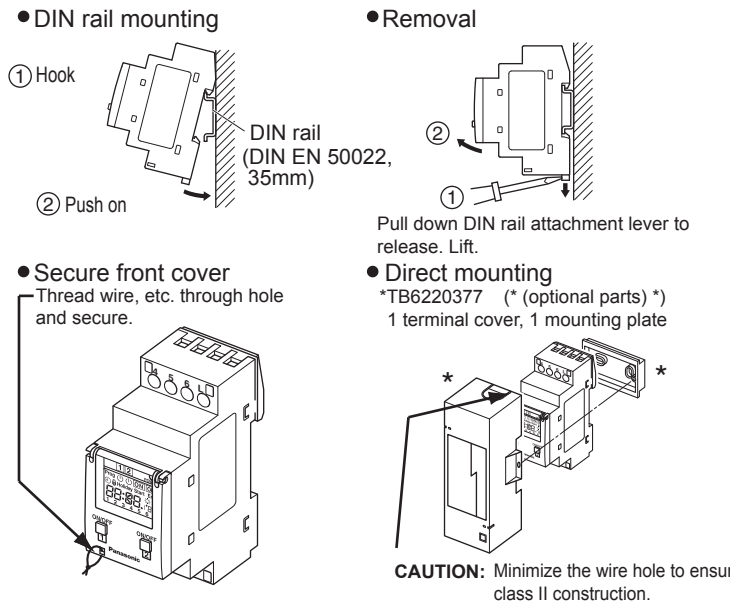

Connection diagram

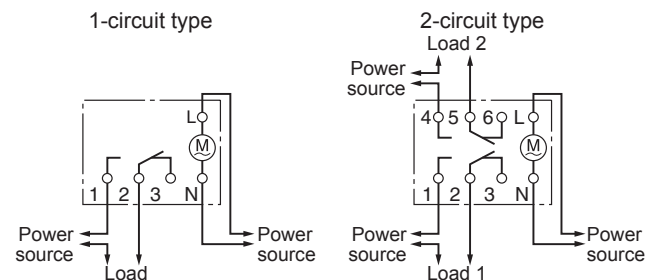

MODE Press "MODE" to set the clock, select the program, make holiday settings and set summer or winter time.

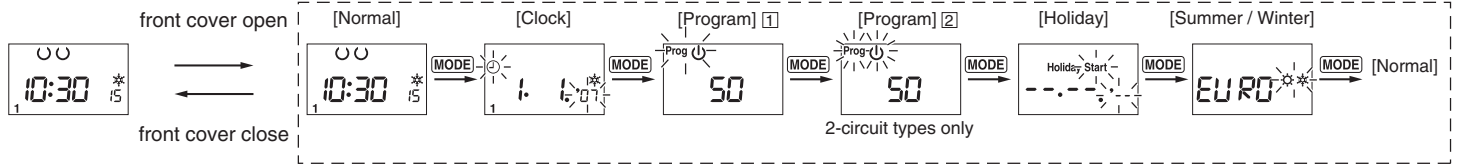

Clock setting

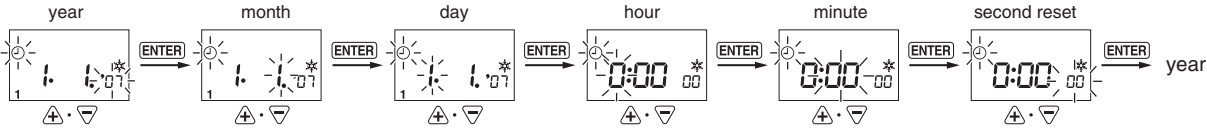

Program setting

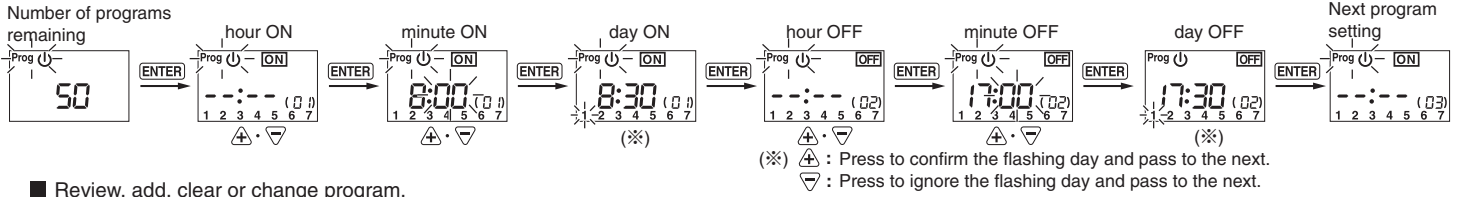

■ Review, add, clear or change program.

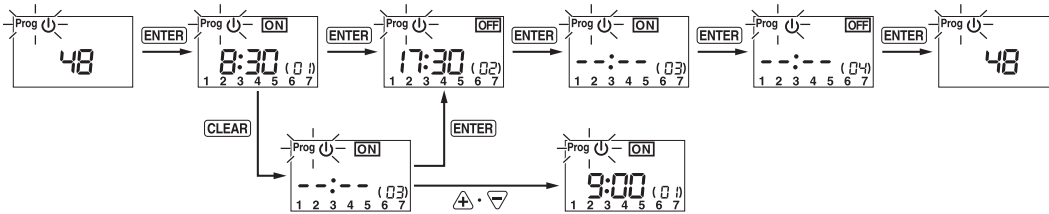

Holiday setting

This function allows you to cancel ON programs for the holidays specified.

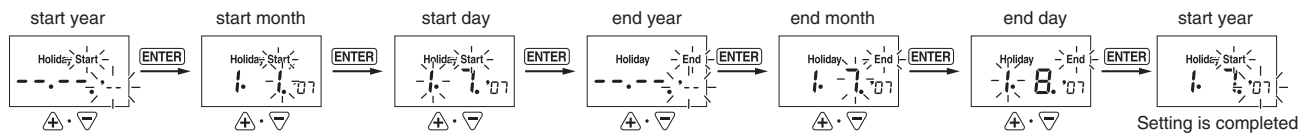

Summer / Winter time setting

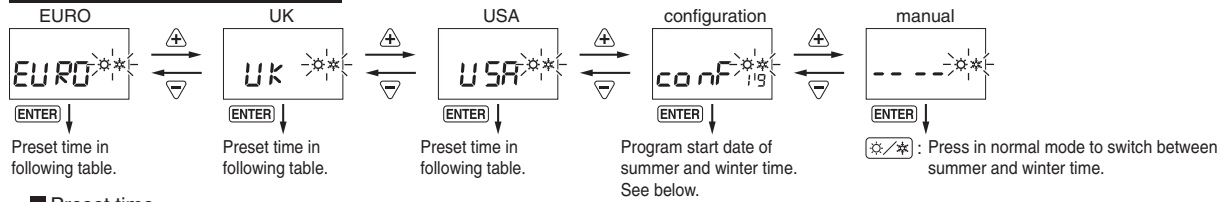

■ Preset time

	Summer time start date	Winter time start date
EURO	Last Sunday in March at 2AM	Last Sunday in October at 3AM
UK	Last Sunday in March at 1AM	Last Sunday in October at 2AM
USA	Second Sunday in March at 2AM	First Sunday in November at 2AM

■ Programming the start date of summer time and winter time

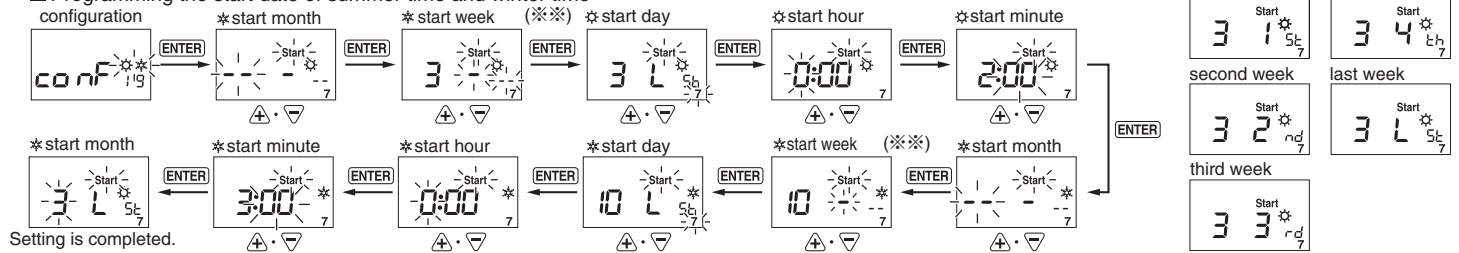

Manual operation

The manual operation button can be operated when the front cover is closed.
Press the manual operation button for 1 second to switch between manual and programmed operation.

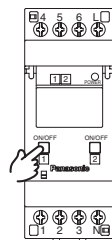

⏏ : Function to lock out manual operation

⏏ + ⏏ : Press these buttons simultaneously to activate or deactivate the lock.

